



MAKSOY Web

Yeşiloba Mahallesi Efer 4 Sanayi Sitesi
No:25 Seyhan / Adana / Turkey
+90 0322 428 32 80

CATALOG 



**Working with clients to
deliver a brighter future**





MAKSOY Makine İmalat San. ve Tic. Ltd. Şti. 2001 yılından beri Türkiye ve Avrupa sanayisinde tecrübe kazanmış kurucuları Selçuk Yaman ve Murat Aksoy önderliğinde 2019 yılında faaliyetlerine başlamıştır. Enerji Santralleri (HES, Biyokütle, Biyogaz, Termik Santraller), Makine-Kimya ve Çimento sanayisinin talaşlı imalat, çelik konstrüksiyon, yakıt kazanları, kırıcı imalatı, konveyör ve konveyör parçaları imalatı, yeni ürün tasarımı, ürün geliştirme, sistem devreye alma ve danışmanlık hizmeti ihtiyaçlarını karşılamak amacıyla kurulmuştur. Kuruluşundan günümüze değin kamu ve özel sektörden gelen siparişleri başarı ile bitirerek teslim etmiş olmanın gururu ile Adana Metal Sanayi bölgesindeki fabrikasında faaliyetini sürdürmektedir.

Uluslararası Kalite Yönetim Sistemi Standardı olarak bilinen ISO 9001:2015 doğrultusunda üretimlerini gerçekleştirmektedir. Sürekli kendini yenileyerek modern teknolojiyi kullanan, Avrupa ve Amerika seyahatleri ile sektördeki güncel gelişmeleri yakından takip eden firmamız bilgili ve deneyimli kadrosu ile verdiği hizmet kalitesini sürekli yükselterek, değerli müşterilerimizin de güven ve takdiri ile bu günlere ulaşmıştır. Firmamız 2020 yılında AR-GE ye yönelik faaliyetlere ağırlık vermiştir. 2021 yılında Türkiye'den Amerika'ya yapılan en büyük AR-GE inovasyon projesi olan 'Biyokütle Atıklarından Enerji Eldesine Yönelik Yüksek Verimlilikte Gazlaştırma Sistemi"ni tasarlayıp imal etmiş olmanın gururunu taşımaktayız. Sistemin Güney Korede kurulumu yapılmış olup başarıyla devreye alınmıştır.

MAKSOY Machinery Manufacturing Industry and Trade Limited Company started its activities in 2019 under the leadership of its founders, Selçuk Yaman and Murat Aksoy, who have gained experience in the Turkish and European industry since 2001. Energy Power Plants (Hydroelectric, Biomass, Biogas, Thermal Power Plants), Machinery-Chemistry and Cement industries with machining was established to meet the needs of manufacturing, steel construction, fuel boilers, crusher manufacturing, conveyor and conveyor parts manufacturing, new product design, product development, system commissioning and consultancy services. The company continues its activities in its factory in the Adana Metal Sanayi zone with pride.

It carries out its production in accordance with ISO 9001:2015, known as the International Quality Management System Standard. Our company, which uses modern technology by constantly renewing itself, and closely follows the current developments in the sector with its European and the USA travels, has reached these days by constantly increasing the service quality it provides with its knowledgeable and experienced staff, and with the trust and appreciation of our valued customers has given weight. We are proud to have designed and manufactured the "High Efficiency Gasification System for Energy Obtaining from Biomass Wastes", which is the biggest R&D innovation project from Turkey to the USA in 2021. The system has been installed in South Korea and has been successfully commissioned.





VİZYONUMUZ

Dijitalleşen ve hızla değişen dünya sanayisinde, faaliyet gösterdiği sektörde her daim müşteri ihtiyaçlarına cevap verebilen yeşil bir geleceğe yatırım yapan lider firma olmak.

MİSYONUMUZ

Güçlü sanayi tecrübelerimiz, firmamızın üretim esnekliği, nitelikli insan kaynağımız ve yenilikçiliği teşvik eden Ar-Ge ekosistemimiz sayesinde müşterilerimizin talep ve beklentilerini karşılayacak verimli, güvenli, kaliteli çözümleri sunmaktır.

OUR VISION

To be the leading company that invests in a green future that can always respond to customer needs in the sector in which it operates in the digitalizing and rapidly changing industry.

OUR MISSION

With our strong industry experience, our company's production flexibility, our qualified human resources and our R&D ecosystem that encourages innovation, it provides efficient, safe, quality solutions that will meet the demands and expectations of our customers. will meet the demands and expectations of our customers.

**"Dream Big
Think Big
Do your Best"**

Maksoy Firma Kùltürümüzün Temelindeki 6 Unsur

There are six-elements to the **MAKSOY** positive attitude

1

Toplam kalite yönetimine tam baęlılık

A Total Commitment to 'Quality'



2

Tasarım odaklı düşünme

Design Thinking

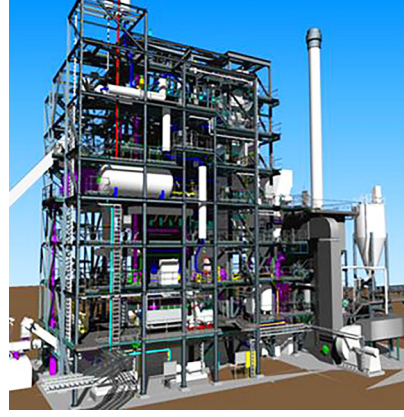

3

Dürüstlükten ödün vermeyen

With a High Level of 'Integrity'



4

Proaktif yaklaşım

With a primary focus on 'Safety'



5

Samimi, işini doğru ve severek yapan

Always remembering to 'Enjoy' life in the Maksoy!



6

inovasyon odaklı

With an objective to 'Innovate'



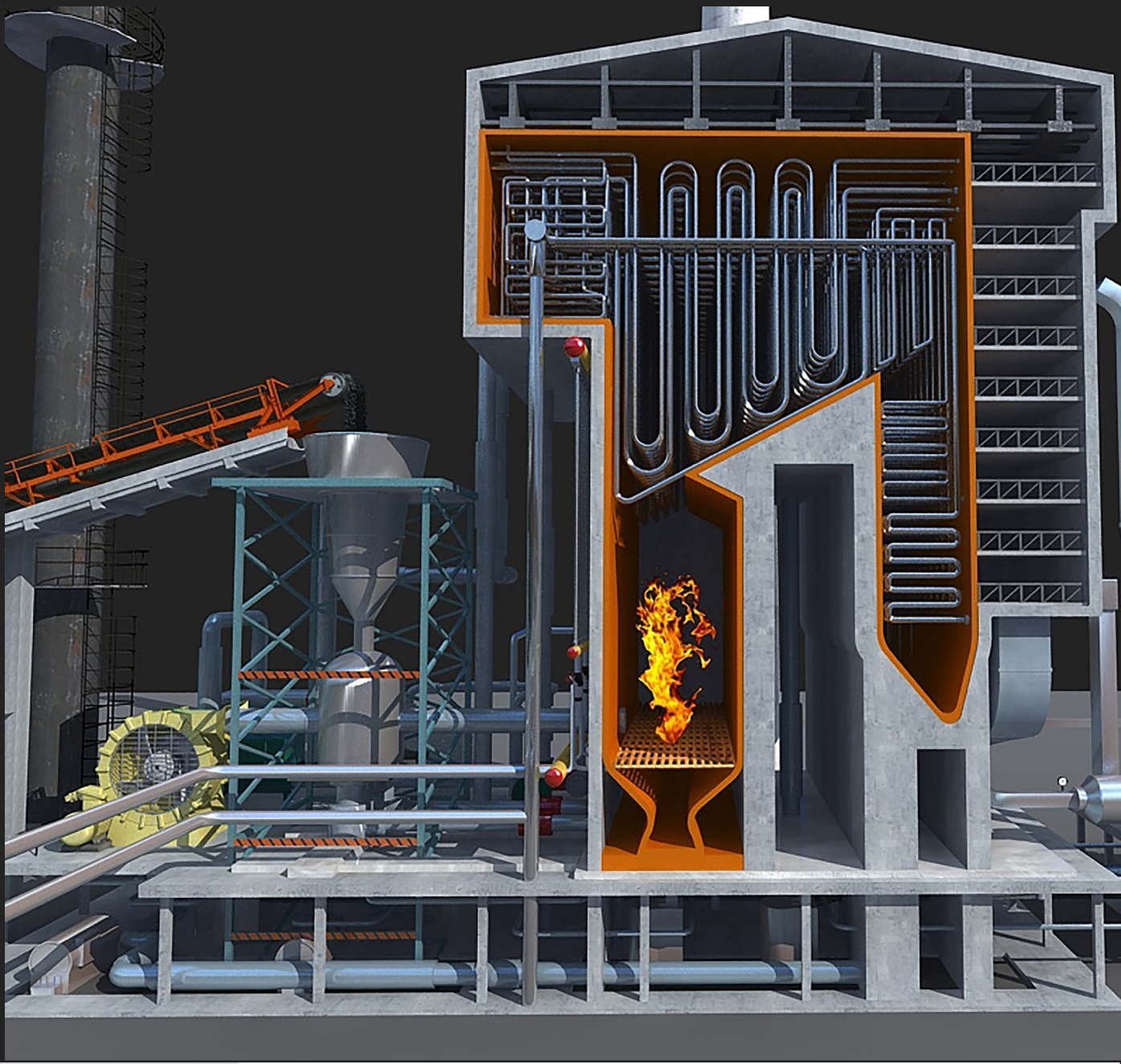

Arařtırmadan, Tasarıma İmalattan, Kurulumu Entegre tedarikçi ve çözümler ortađınız

From Survey to Drawing to Production to Installation Your integrated supplier&solution partner

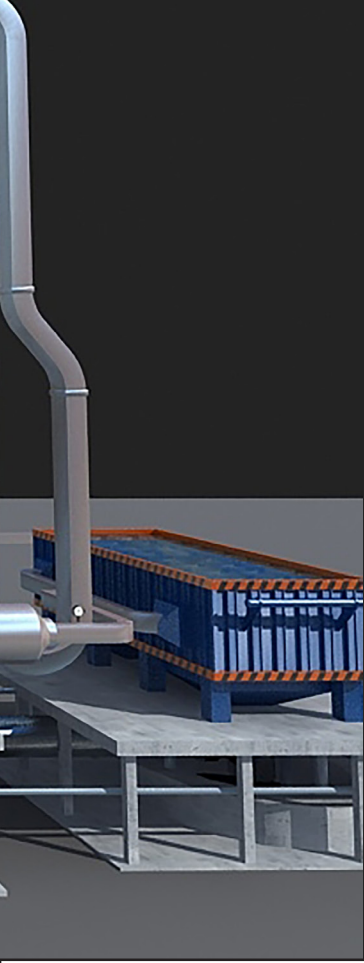

-
-
-
-
-
-

Enerji santrallerinde yakma ve buhar üretmenin zorlu ortamında, tesis ve ekipmanın yenilenme ve değiştirilme işlemlerine sürekli olarak gereksinim vardır.

Maksoy, müşterilerin ekipmanlarının en iyi durumda olmasını sağlamak için; imalat yetenekleri ve geniş mühendislik hizmetleri yelpazesi sayesinde sektörde emre amede hizmet verecek donanıma sahip bir işletmedir.

In the aggressive environment of incineration and steam raising there is an ongoing requirement for refurbishment and replacement of plant and equipment in all areas of the process. Maksoy is a bussiness equipped to serve the industry with a full spectrum of engineering services to ensure customers equipment is in the best condition in order to maintain essential processes.

Neler Yapıyoruz? What we do?

TALAŞLI İMALAT FAALİYETLERİMİZ Manufacturing capabilities

Maksoy, modern bir imalat atölyesinde en iyi üretim teknikleri üzerinde çalışan yalın bir kuruluştur. Güvenli bir ortamda üretilen; en yüksek kalitede, tutarlı ve rekabetçi ürünler sağlayan yönetim sistemleri izlenmektedir. Kalite hedeflerinin izlenmesini ve sürdürülmesini sağlamak için tüm üretim, ISO9000'in en son 2015 standardına göre yapılır.

Maksoy is a lean enterprise working a modern manufacturing facility best production techniques. Management systems that ensures highest quality, consistent and competitive products produced in a safe environment. All manufacturing is conducted within the dictates of ISO9000 to the latest 2015 standard to ensure quality objectives are monitored and maintained. innovation, it provides efficient, safe, quality solutions that will meet the demands and expectations of our customers.

MUHTELİF TALAŞLI İMALAT Manufacturing

Sahip olduğumuz universal torna tezgahlar ve CNC tezgahlar sayesinde her ölçüde malzemeyi hassas işleyebilmekteyiz.

With our universal lathes and CNC lathes, we can precisely manufacture materials of all sizes.



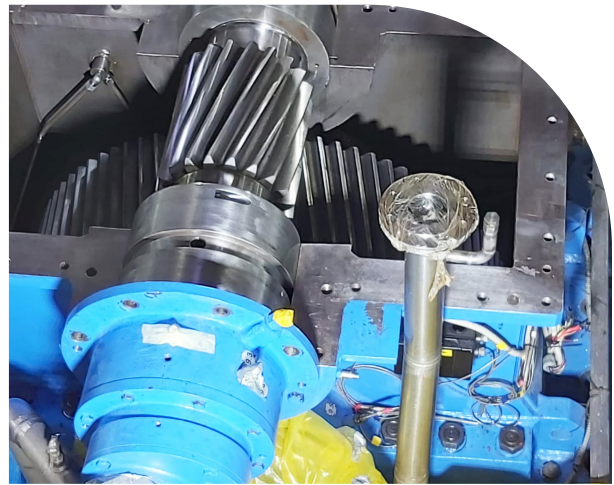
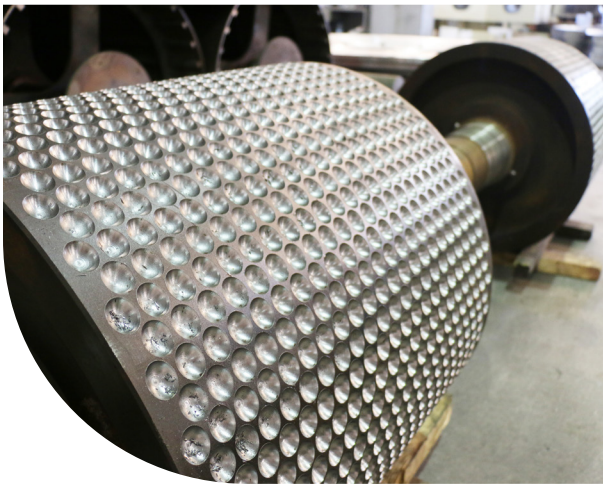
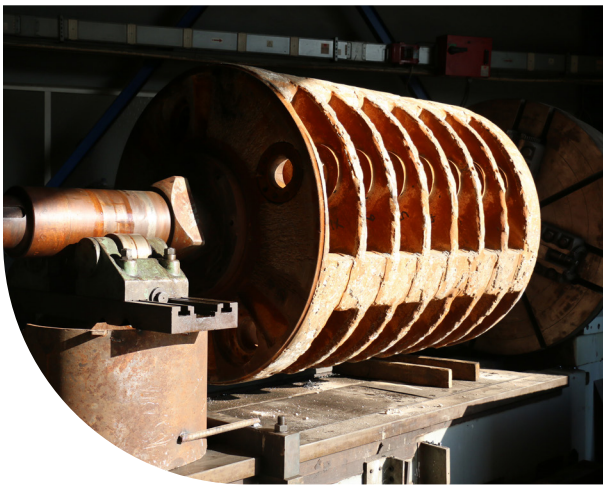

“Our Factory Is Satisfactory”



Neler Yapıyoruz? What we do?

ÇELİK KONSTRÜKSİYON VE KAYNAKLI İMALAT

Welding and Fabrication

Çelik konstrüksiyon imalatlarımız; proje safhasından, sac ve profillerin şekillendirilmesi, kaynaklı imalatlar, kumlama, boyama ve montaja kadar mühendislerimiz kontrolünde yapılmaktadır.

Kaynak işlemi yaptığımız ürünler kaynak mühendislerimizin ve sertifikalı kontrol birimlerimiz tarafından takip edilerek, EN Kalite Standartlarına uygun olarak imal edilmektedir.

Our steel construction productions; From the project to the shaping of sheet metal and profiles, welded fabrications, sandblasting, painting and assembly, it is carried out under the control of our engineers.

The products we weld are followed by our welding engineers and certified control units and are manufactured in accordance with EN Quality Standards.





Neler Yapıyoruz?

What we do?

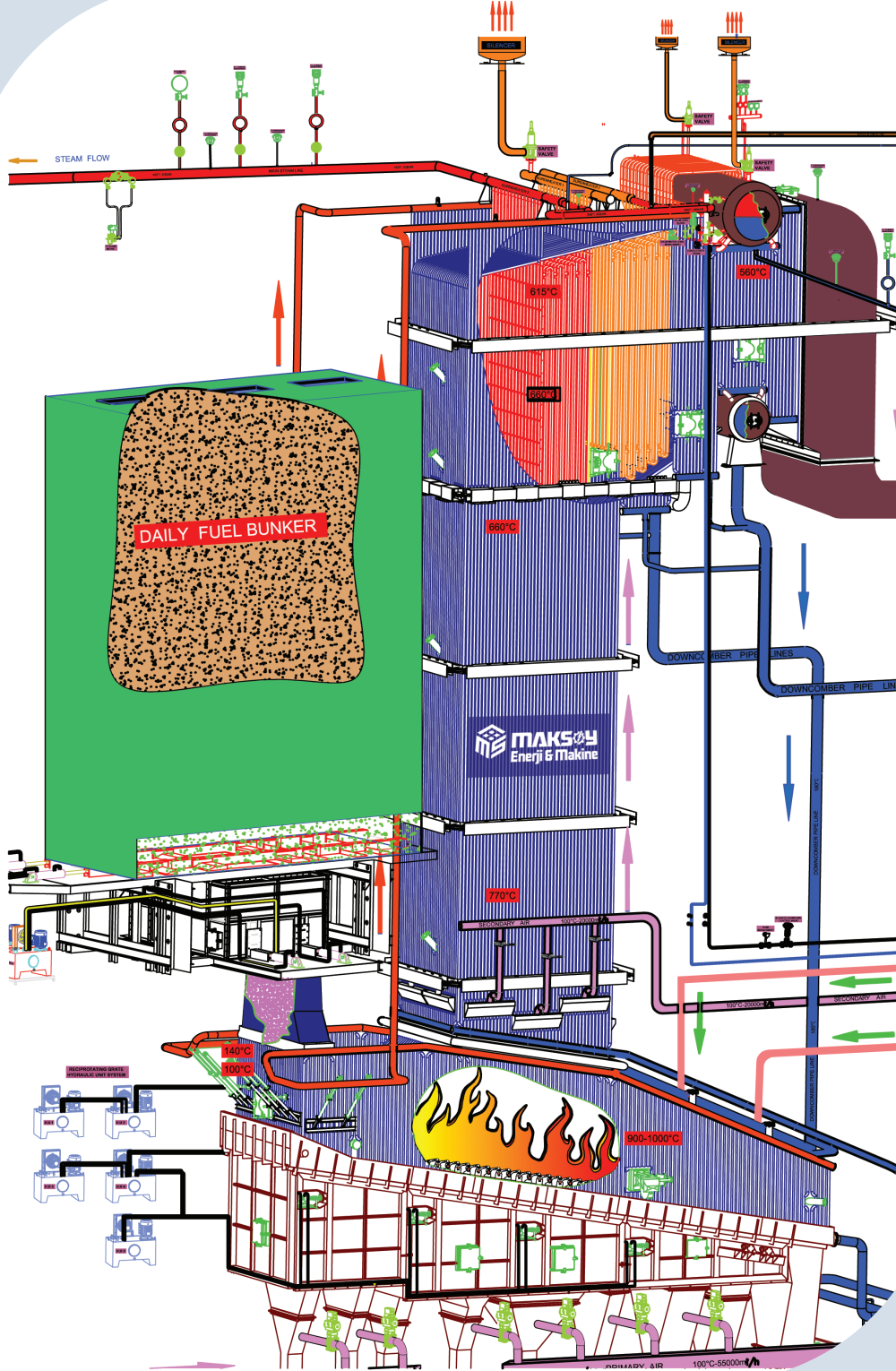

Endüstriyel İmalatlar

Industrial Manufacturing

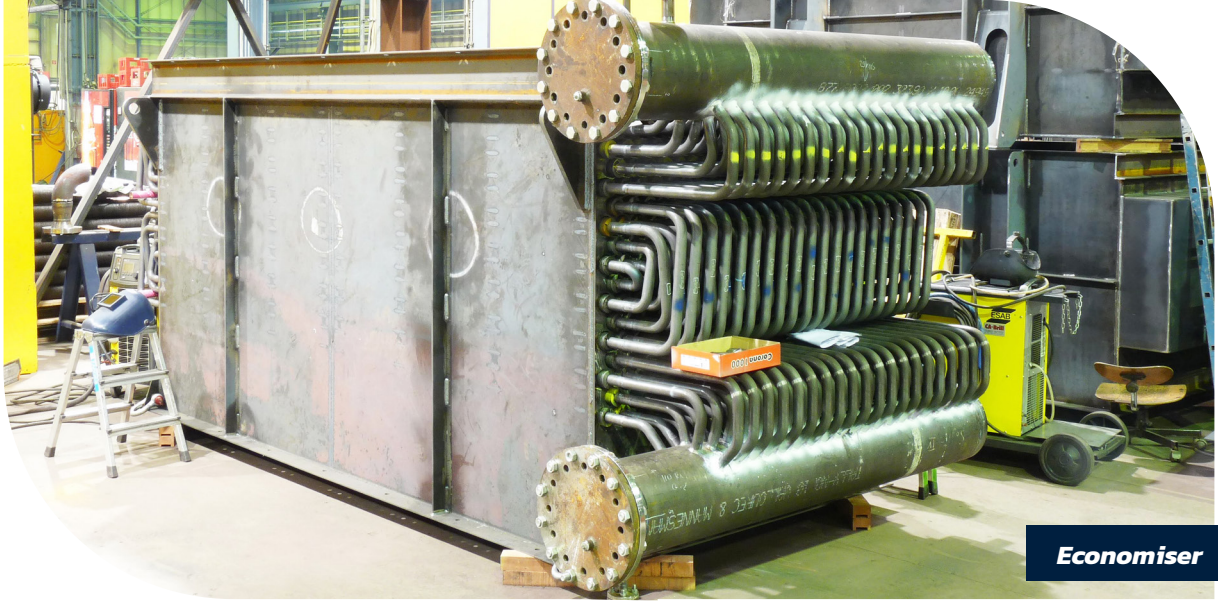

Economiser



Reciprocating Grate



Eşanjör / Heat Exchanger



Silo



Kazan Kollektörü İmalatı
Boiler Collector Manufacturing

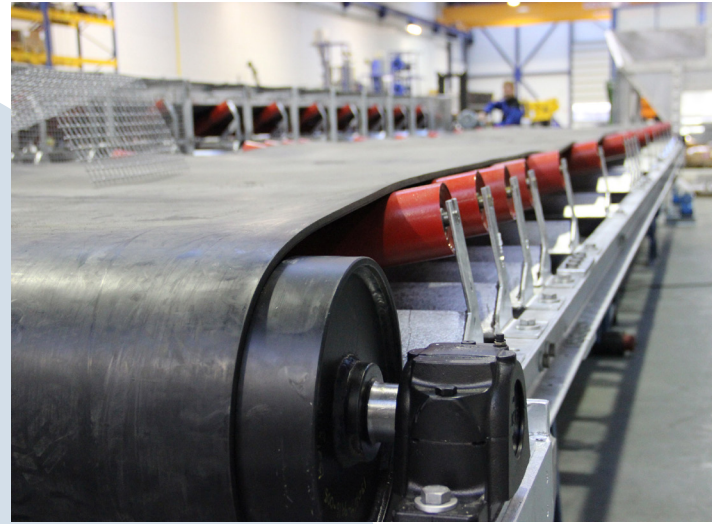

Neler Yapıyoruz? What we do?





Balya Kırıcıları
Bale crusher

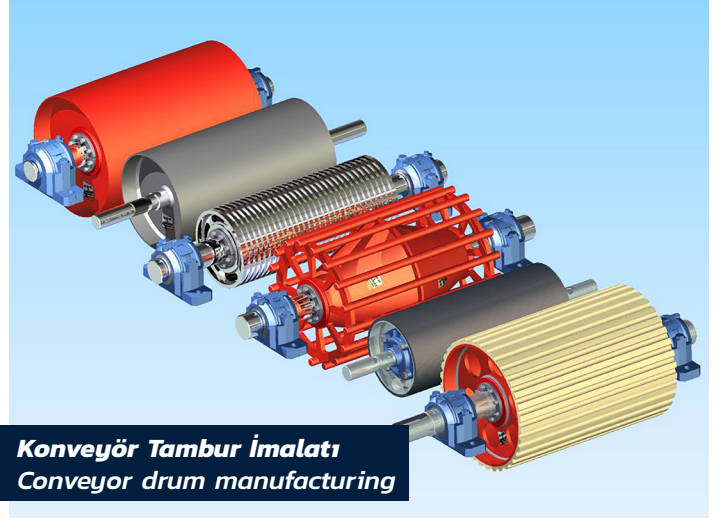

Konveyör Tambur İmalatı
Conveyor drum manufacturing



Roller Chain Manufacturers

KONVEYÖR VE KONVEYÖR PARÇALARI

CONVEYOR AND CONVEYOR PARTS

Helisel konveyör, Rulo konveyör, Tambur veya zincir tahrikli bant konveyör, Taşınabilir bant konveyör, Konveyör rulo istasyonu, Rulo ve tahrik tamburu, Konveyör yükleme hunisi, Hazne konstrüksiyonları, Hopper kepenk.

Helical conveyor, Roller conveyor, Drum or chain driven belt conveyor, Portable belt conveyor, Conveyor roller station, roller and drive drum, Conveyor loading hopper, Hopper constructions, Hopper shutter.



Neler Yapıyoruz?

What we do?

ÖZEL MAKİNA TASARIM İMALATI
NEW MACHINE DESIGN & MANUFACTURING



İhtiyacınıza uygun makınayı sizin için tasarlıyor ve üretiyoruz.
We design and manufacture the machine suitable for your needs.

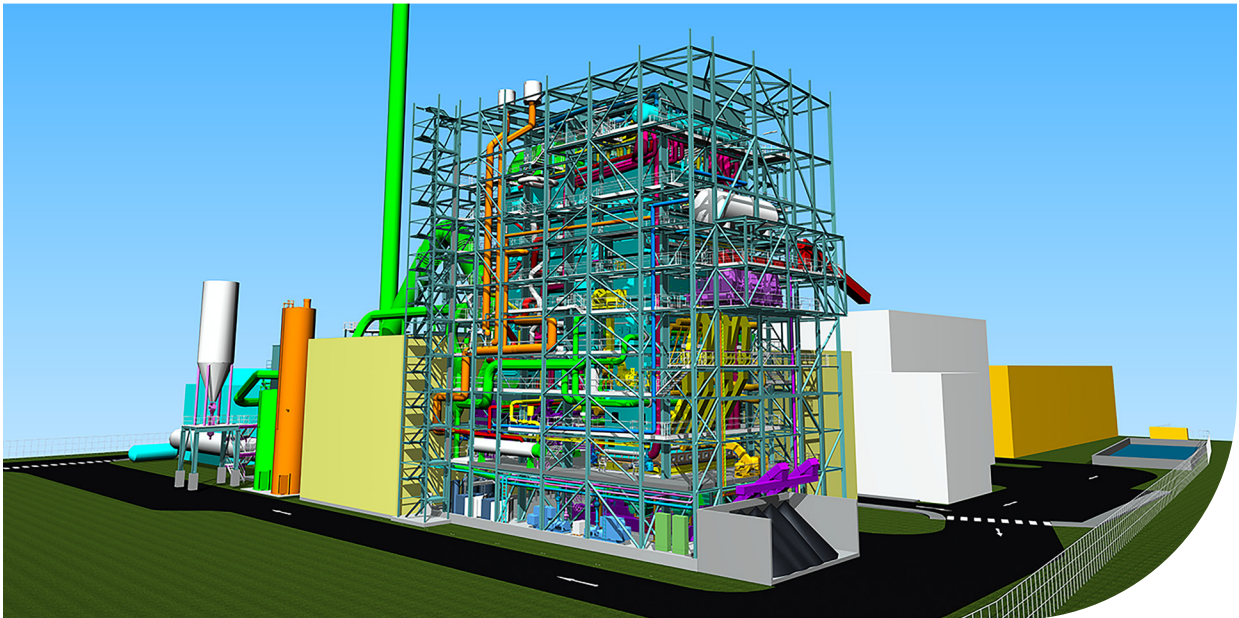

Neler Yapıyoruz?

What we do?

“ Siz kahvenizi için biz atığından enerji üretelim
You drink coffee we produce energy from its waste



SAHA MONTAJI SIDE INSTALLATION

Güney Kore'de devreye aldığımız kahve atıklarından enerji üreten gazlaştırma tesisi

We have commissioned a gasification plant in South Korea that produces energy from coffee waste



Yeşil bir geleceğe yatırım
Investing in a green future 



Neler Yapıyoruz?

What we do?



SAHA MONTAJI
SIDE INSTALLATION

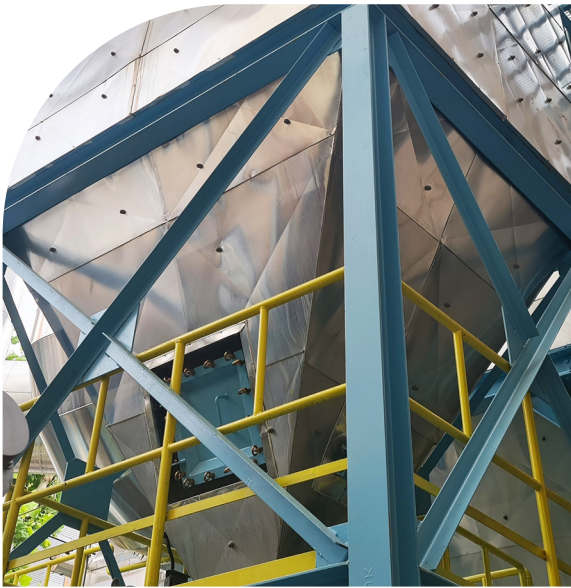

Swirl Burner Firing



Insulation Work

Neler Yapıyoruz? What we do?

PNÖMATİK VE HİDROLİK KLAPELER

HYDRAULIC & PNEUMATIC FLAPS



Çimento Fabrikaları, Enerji santralleri ve endüstriyel tesisler için akışı kontrol edecek ya da tam sızdırmaz şekilde kesecek çok çeşitli klapeler ve damperler imal edilebilmektedir.

A wide variety of flaps and dampers can be manufactured for Cement Factories, Power Plants and industrial plants to control the flow or to cut it completely tight.



ROTARY VALVE / HAVA KİLİDİ / HÜCRE TEKERİ / YILDIZ KLAPE

Kullanılacak Hammaddenin ısısı, basınç sınıfı ve aşındırıcı etkisine göre kanat toleranslarını belirlediğimiz rotary valveleri proses kapasitesine uygun olarak üretiyoruz. Farklı uygulamalar ve farklı hammaddeler için çeşitli modeller bulunmaktadır. Kullanım yerine göre (silo, siklon, jet filtre, konveyör, havalı taşıma sistemleri vb), aktarılabacak malzemeye göre (tozsuz, granül, esnek, aşındırıcı, sert vb), ortam şartlarına göre (sıcaklık, nem, korozyon vb) uygun hava kilidi (hücre tekeri) tasarımı ve imalatı yapıyoruz.

We manufacture rotary valves in accordance with the process capacity, for which we determine the blade tolerances according to the temperature, pressure class and corrosive effect of the raw material to be used. Various models are available for different applications and different raw materials. We design and manufacture rotary valve according to the place of use (silo, cyclone, jet filter, conveyor, air transport systems, etc.), according to the material to be transferred (powdered, granular, flexible, abrasive, hard, etc.), according to the ambient conditions (temperature, humidity, corrosion, etc.)



Neler Yapıyoruz?

What we do?

YÜRÜYEN TABAN BESLEME SİSTEMLERİ

MOVING FLOOR FEEDING SYSTEM



Dökme malzemeler, atık, hurda metaller, organik gübre, paletler, ağaç ürünleri bidonlar, balyalar, rulolar gibi birçok malzemenin taşınmasına olanak sağlayan walking floor sistemlerinin tasarım ve imalatını yapıyoruz. WALKING FLOOR sistemine sahip treyler çok yönlülüğü sayesinde yukarıdan yüklemelerde, balya tipi yüklemelerde ve rulo tipi yüklemelerde verimli bir şekilde kullanılır. Sistemlerin bakım maliyetleri düşüktür ve işletmesi kolaydır.

We design and manufacture walking floor systems that allow the transportation of many materials such as bulk materials, waste, scrap metals, organic fertilizers, pallets, wood products, drums, bales, and rolls. Thanks to its versatility, the trailer with the WALKING FLOOR system can be used efficiently in overhead loading, bale-type loading and roll-type loading. The systems have low maintenance costs and are easy to operate.



HURDA KAPMA POLİP İMALATI

SCRAP GRAPPER

Hurda yığınlarını toplama ve aktarma için imal edilen polipler Hidrolik ve Manuel olarak iki şekilde, aşınmaya dirençli çelikler kullanılarak üretimi yapılmaktadır.

Scrap Grapper, which are manufactured for collecting and lifting scrap piles, are produced in two ways as hydraulic and manual, using high-resistant steels.

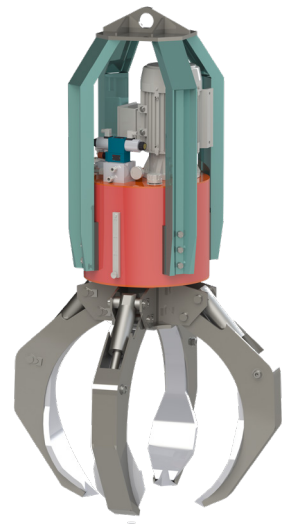

RDF (ÇÖP) PARÇALAYICILAR

REFUSE DERIVED FUEL CRUSHER



Neler Yapıyoruz?

What we do?

İŞ MAKİNALARI VE HİDROLİK SİLİNDİRLER

Construction Equipment and Hydraulic Cylinders

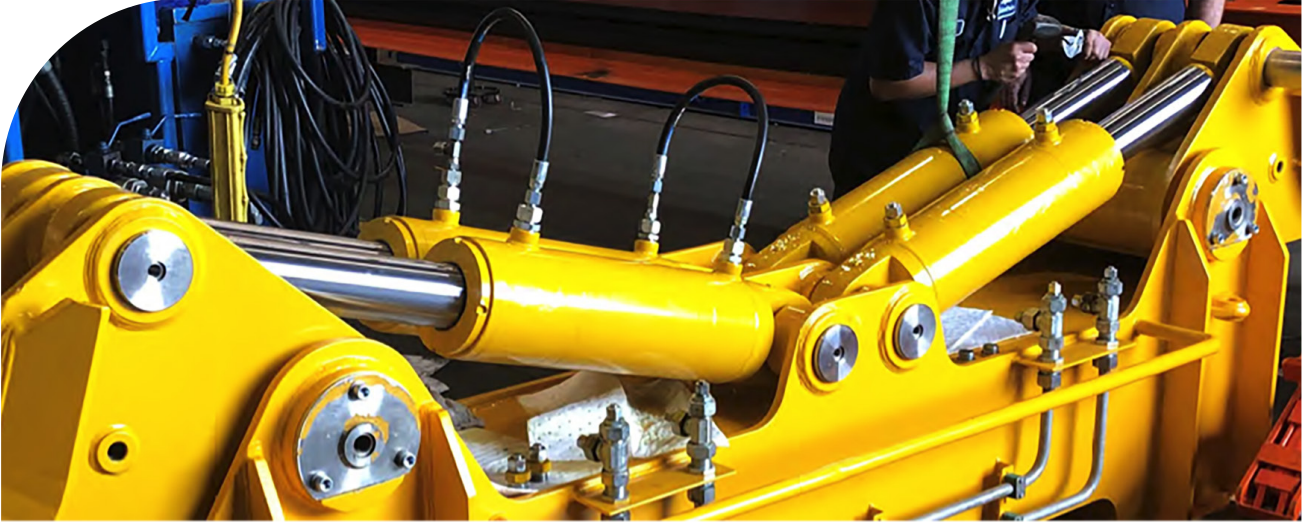

Her tipte özel hidrolik silindir imalatı.

Production of special hydraulic cylinders of all types.

SERTİFİKALAR

CERTIFICATES

BOS
BEST QUALITY SERVICES

CERTIFICATE

This certificate is granted to the organization,
MAKSOY MAKİNE İMALAT SANAYİ VE TİCARET LİMİTED ŞİRKETİ
Yesiloba Mahallesi 1. Cadde No:134/225 Seyhan, Adana, TURKEY

Manufacture of Machinery and Spare Parts

EA 18
according to the scope,
TS EN ISO 14001:2015
to certify that environmental management system in accordance with standard's clauses is established and being implemented.

Date of First Issue : 05.06.2020
Date of Issue : 05.06.2021
Certificate Period : 3 Year
Release Date : 04.06.2022
Certificate No : CE.2021.554

Best Quality Services
System Certificate Approved

BOS
BEST QUALITY SERVICES

BOS
Belgeleme ve Eğitim Hizmetleri Ltd. Şti.
Makineçiler Mahallesi 7933 Sokak No:217, Hürriyet Kavşağı 8 Blok Kat:2
Gölcük Mahallesi/20250
Tel: 0322 224 81 12 Fax: 0322 222 22 22 E-mail: info@bos.com.tr

BOS
BEST QUALITY SERVICES

CERTIFICATE

This certificate is granted to the organization,
MAKSOY MAKİNE İMALAT SANAYİ VE TİCARET LİMİTED ŞİRKETİ
Yesiloba Mahallesi 1. Cadde No:134/225 Seyhan, Adana, TURKEY

Manufacture of Machinery and Spare Parts

EA 18
according to the scope,
TS EN ISO 9001:2015
to certify that quality management system in accordance with standard's clauses is established and being implemented.

Date of First Issue : 05.06.2020
Date of Issue : 05.06.2021
Certificate Period : 3 Year
Release Date : 04.06.2022
Certificate No : KQ.2021.554

Best Quality Services
System Certificate Approved

BOS
BEST QUALITY SERVICES

BOS
Belgeleme ve Eğitim Hizmetleri Ltd. Şti.
Makineçiler Mahallesi 7933 Sokak No:217, Hürriyet Kavşağı 8 Blok Kat:2
Gölcük Mahallesi/20250
Tel: 0322 224 81 12 Fax: 0322 222 22 22 E-mail: info@bos.com.tr

BOS
BEST QUALITY SERVICES

CERTIFICATE

This certificate is granted to the organization,
MAKSOY MAKİNE İMALAT SANAYİ VE TİCARET LİMİTED ŞİRKETİ
Yesiloba Mahallesi 1. Cadde No:134/225 Seyhan, Adana, TURKEY

Manufacture of Machinery and Spare Parts

according to the scope,
ISO 45001:2018
to certify that Occupational Health and Safety Management System in accordance with standard's clauses is established and being implemented.

Date of First Issue : 05.06.2020
Date of Issue : 05.06.2021
Certificate Period : 3 Year
Release Date : 04.06.2022
Certificate No : İO.2021.554

Best Quality Services
System Certificate Approved

BOS
BEST QUALITY SERVICES

BOS
Belgeleme ve Eğitim Hizmetleri Ltd. Şti.
Makineçiler Mahallesi 7933 Sokak No:217, Hürriyet Kavşağı 8 Blok Kat:2
Gölcük Mahallesi/20250
Tel: 0322 224 81 12 Fax: 0322 222 22 22 E-mail: info@bos.com.tr

BOS
BEST QUALITY SERVICES

SERTİFİKA

Bu Sertifika,
MAKSOY MAKİNE İMALAT SANAYİ VE TİCARET LİMİTED ŞİRKETİ
Yesiloba Mahallesi 46303 Sokak Efer 3 Sanayi Sitesi No:4 C Seyhan/ADANA
kuruluşunun,
Makine ve Yedek Parça Üretimi

EA 18
kapsamında,
TS EN ISO 14001:2015
Çevre Yönetim Sistemi Standartının şartlarına uyan bir yönetim sistemi kurduğunu ve uyguladığını onaylamak üzere verilmiştir.

İlk Yayın Tarihi : 05.06.2020
Belge Tarihi : 05.06.2021
Belge Periyodu : 3 Yıl
Bitiş Tarihi : 04.06.2022
Sertifika No : CE.2020.554

Best Quality Services
Sertifika Onay

BOS
BEST QUALITY SERVICES

BOS
Belgeleme ve Eğitim Hizmetleri Ltd. Şti.
Makineçiler Mahallesi 7933 Sokak No:217, Hürriyet Kavşağı 8 Blok Kat:2
Gölcük Mahallesi/20250
Tel: 0322 224 81 12 Fax: 0322 222 22 22 E-mail: info@bos.com.tr

BOS
BEST QUALITY SERVICES

SERTİFİKA

Bu Sertifika,
MAKSOY MAKİNE İMALAT SANAYİ VE TİCARET LİMİTED ŞİRKETİ
Yesiloba Mahallesi 1. Cadde No:134/225 Seyhan/ADANA
kuruluşunun,
Makine ve Yedek Parça Üretimi

EA 18
kapsamında,
TS EN ISO 9001:2015
Kalite Yönetim Sistemi Standartının şartlarına uyan bir yönetim sistemi kurduğunu ve uyguladığını onaylamak üzere verilmiştir.

İlk Yayın Tarihi : 05.06.2020
Belge Tarihi : 05.06.2021
Belge Periyodu : 3 Yıl
Bitiş Tarihi : 04.06.2022
Sertifika No : KQ.2021.554

Best Quality Services
Sertifika Onay

BOS
BEST QUALITY SERVICES

BOS
Belgeleme ve Eğitim Hizmetleri Ltd. Şti.
Makineçiler Mahallesi 7933 Sokak No:217, Hürriyet Kavşağı 8 Blok Kat:2
Gölcük Mahallesi/20250
Tel: 0322 224 81 12 Fax: 0322 222 22 22 E-mail: info@bos.com.tr

BOS
BEST QUALITY SERVICES

SERTİFİKA

Bu Sertifika,
MAKSOY MAKİNE İMALAT SANAYİ VE TİCARET LİMİTED ŞİRKETİ
Yesiloba Mahallesi 1. Cadde No:134/225 Seyhan/ADANA
kuruluşunun,
Makine ve Yedek Parça Üretimi

EA 18
kapsamında,
ISO 45001:2018
İş Sağlığı ve Güvenliği Yönetim Sistemi Standartının şartlarına uyan bir yönetim sistemi kurduğunu ve uyguladığını onaylamak üzere verilmiştir.

İlk Yayın Tarihi : 05.06.2020
Belge Tarihi : 05.06.2021
Belge Periyodu : 3 Yıl
Bitiş Tarihi : 04.06.2022
Sertifika No : İO.2021.554

Best Quality Services
Sertifika Onay

BOS
BEST QUALITY SERVICES

BOS
Belgeleme ve Eğitim Hizmetleri Ltd. Şti.
Makineçiler Mahallesi 7933 Sokak No:217, Hürriyet Kavşağı 8 Blok Kat:2
Gölcük Mahallesi/20250
Tel: 0322 224 81 12 Fax: 0322 222 22 22 E-mail: info@bos.com.tr

WE HELP PROJECTS RUN SMOTHER



MAKSOY Web

Yeşiloba Mahallesi Efer 4 Sanayi Sitesi No:25 Seyhan / Adana / Turkey
info@maksoymakine.com • www.maksoymakine.com
+90 0322 428 32 80